

2008

Open Circuit Potential Shifts of Activated Carbon in Aqueous Solutions During Chemical and Adsorption Interactions

Mikhail M. Goldin

Liberty University, mgoldin@liberty.edu

Vladimir A. Kolesnikov

Mogely Sh. Khubutiya

Alexander G. Volkov

Gary J. Blanchard

See next page for additional authors

Follow this and additional works at: https://digitalcommons.liberty.edu/bio_chem_fac_pubs

 Part of the [Biology Commons](#), and the [Chemistry Commons](#)

Recommended Citation

Goldin, Mikhail M.; Kolesnikov, Vladimir A.; Khubutiya, Mogely Sh.; Volkov, Alexander G.; Blanchard, Gary J.; Evseev, Anatoly K.; and Goldin, Mark M., "Open Circuit Potential Shifts of Activated Carbon in Aqueous Solutions During Chemical and Adsorption Interactions" (2008). *Faculty Publications and Presentations*. 99.

https://digitalcommons.liberty.edu/bio_chem_fac_pubs/99

This Article is brought to you for free and open access by the Department of Biology and Chemistry at Scholars Crossing. It has been accepted for inclusion in Faculty Publications and Presentations by an authorized administrator of Scholars Crossing. For more information, please contact scholarlycommunications@liberty.edu.

Author(s)

Mikhail M. Goldin, Vladimir A. Kolesnikov, Mogely Sh. Khubutiya, Alexander G. Volkov, Gary J. Blanchard, Anatoly K. Evseev, and Mark M. Goldin

Open Circuit Potential Shifts of Activated Carbon in Aqueous Solutions during Chemical and Adsorption Interactions

Mikhail M. Goldin,¹ Vladimir A. Kolesnikov,² Mogely Sh. Khubutiya,² Alexander G. Volkov,^{3*} Gary J. Blanchard,¹ Anatoly K. Evseev,² Mark M. Goldin²

¹*Department of Chemistry, Michigan State University, East Lansing, MI 48824-1322, USA*

²*N.V. Sklifosovsky Research Institute for Emergency Medicine, Moscow 129010, Russia*

³*Department of Chemistry, Oakwood University, 7000 Adventist Blvd., Huntsville, AL 35896, USA*

Abstract

Interaction of certain inorganic and organic compounds with activated carbon and the effect of such interaction on open circuit potential of activated carbon were studied. Open circuit potential shifts were observed for an overwhelming majority of the substances and brands of activated carbons investigated. Both negative and positive potential shifts were observed. It was shown that open circuit potential shifts for organic substances depend on degree of coverage of the activated carbon surface. Whereas adsorption of investigated organic compound on activated carbon led to positive potential shifts, desorption of adsorbates from the activated carbon surface led to potential shifts in the opposite direction. Furthermore, time dependencies of open circuit potential shifts were similar for different carbon brands. The magnitude of the shifts depended on the adsorbate, adsorption activity of the adsorbent, and the steric configuration of potential-determinative pores and adsorbate molecules.

Keywords: activated carbon; open circuit potential; adsorption; potential shifts; potential-determinative pores.

* Corresponding author: Professor Alexander George Volkov, Phone/Fax: (256) 726-7113; E-mail: agvolkov@oakwood.edu

Introduction

Open circuit potential shifts in the course of interaction of platinum electrodes with inorganic compounds were first observed by Frumkin *et al.* [1] and later were studied in detail on catalytically active metals of the platinum group with formation of adatoms [2]; open circuit potentials and total charge during the adsorption of carbon monoxide have also been studied on a platinum electrode [3]. The relationship between pulses of current and open circuit potentials for strong adsorption of neutral species and ions were studied on a hydrogen electrode [4]. Negative potential shifts were obtained during adsorption of iodide ions on modified platinum electrodes [5]. Similar shifts also occur on other metal electrodes due to adsorption of organic compounds [6]. However, this phenomenon has not been studied sufficiently on porous carbon electrodes; moreover, the nature of the shifts is still unclear. In addition, measurements of open circuit potential shifts in time during adsorption or other interactions in the system of activated carbon and inorganic or organic compound in the presence of dissolved oxygen are few in literature. This phenomenon for the adsorption of Ag^+ and Cu^{2+} cations on preliminary polarized activated carbons was described by Goldin *et al* [7].

Fundamental studies of electrochemical behavior and adsorption properties of activated carbons have led to a unified electrochemical theory of adsorption on activated carbons [1]. According to this theory, activated carbon immersed in water adsorbs dissolved oxygen from water, in the form of $\text{C}^+\dots\text{O}^-$, thereby becoming an oxygen electrode.

The Frumkin theory for carbons, as part of his general theory of adsorption of ions and organic molecules on electrodes [1,8], was key to understanding the necessity of taking into account the electrochemical properties of adsorption processes on activated carbons. The influence of interaction of oriented water dipoles and adsorbate molecules on the mechanism of adsorption was developed by Bockris *et al.* [9,10]. The electrochemical theory is still used today for adsorption studies on activated carbons [7,11,12] development of new electrosorption processes on activated carbon [13] and other porous carbon materials [14].

It should be emphasized that, from the opposing viewpoint, adsorption and ion-exchange properties of activated carbons should be determined by the composition and

chemical properties of substances on the surface of activated carbons [15,16,17] However, the electrochemical theory covers more completely the phenomena and properties of the electrode/solution system with dissolved oxygen; moreover, only a combination of electrochemical, chemical, hydrophobic-hydrophilic properties of surface compounds, as well as structural parameters of activated carbons, could yield a more complete understanding of the phenomena occurring at the interface between activated carbon and solution [18].

In spite of the perennial, active interest in adsorption on porous carbon materials and the development of a theoretical electrochemical conception of the process, one important aspect of electrochemical behavior of carbon electrode has not yet attracted attention of researchers—*viz.*, open circuit potential shifts of activated carbon due to adsorption or other interactions with inorganic and organic substances.

The goal of the present work was to measure open circuit potentials of activated carbon during the interaction of aqueous solutions of certain inorganic and organic compounds with granulated activated carbon of different brands; such data may help elucidate the mechanism of this phenomenon.

Methods

Open circuit potentials were measured in the course of adsorption or other interactions of inorganic and organic substances with carbons. The following inorganic salts and organic compounds were studied: Na_2SO_4 , Na_2SO_3 , CuSO_4 , ZnSO_4 , NaNO_3 , NaNO_2 , $\text{K}_2\text{Cr}_2\text{O}_7$, $\text{K}_4[\text{Fe}(\text{CN})_6]$, $\text{K}_3[\text{Fe}(\text{CN})_6]$, acetone, 2-propanol, sodium barbital (Medinal), albumin. Concentrations of salts and organic compounds were 0.01 M. The brands of activated carbons investigated and their main characteristics are shown in Table 1. Potentials of activated carbon were measured in time against the silver/silver chloride reference electrode. The above measurements seem very straightforward at first sight. However, the activated carbons investigated are granulated, their granules quite fragile [19]. Undoubtedly, ensuring a good electrical contact between the granules is an important condition of obtaining reproducible measurements of activated carbon potential. Therefore, it was especially important to provide proper electrical contact between granules, at the same time keeping the pressure on the granules low, so as to avoid

Table 1 Brands and characteristics of studied activated carbons

| Brand | Size of granules (mm) | Packed density (g/dm ³) | Mechanical article strength (%) | Total pore volume (cm ³ /g) | Micropore volume (cm ³ /g) | Specific surface (m ² /g) | Raw stock |
|--------|-----------------------|-------------------------------------|---------------------------------|--|---------------------------------------|--------------------------------------|----------------|
| AG-3A | 0.5 - 1.5 | 480 | > 0.75 | 0.75 | 0.27 | >1000 | Black coal |
| AR-3 | 1.0-5.5 | 550 | 90 | 0.70 | 0.33 | 1100 | Fossil coal |
| SKT-6A | 0.5-2.0 | 380 | 65-70 | 1.11 | 0.60 | 1100 | Peat (Turf) |
| AKU | 0.5-2.8 | 480 | 70 | 0.50 | 0.35 | 1050 | Apricot kernel |
| VSK | 0.5-1.5 | 380 | 75 | 0.80 | 0.60 | 1200 | Cherry kernel |
| SIT-1 | 0.9-2.0 | 540 | 80 | 0.83 | 0.4 | 1200 | Fossil coal |

destruction of granules and dust formation.

The above considerations were taken into account in designing a special column for measurements with granulated carbon, shown on Fig. 1. It was found that tightness, good conductivity, and integrity of carbon granules were ensured if the dry weight of carbon sample was *ca.* 2.0 - 3.0 g (or the weight of a sample wetted with deionized water, *ca.* 3.5 - 7.0 g), depending on the brand of activated carbon. The electrical resistance of active carbon samples in the assembled device was 24.8 - 250 Ω , while the electrical resistance of wetted samples was 6 - 64 Ω .

The column comprised the casing **1** and clamp cover **2**, both made of Teflon, stainless steel bottom **3** and upper **4** meshes that were quite elastic in order to provide the necessary pressure on the carbon granules **5** placed inside an empty compartment in the casing base **1** (Figure 1). The device was assembled in the following way: a sample of activated carbon was placed into the empty space inside the base **1**, then the upper mesh **4** and rubber gasket **6** were placed on top, with the cover **2** placed over it. Four screws **7** with nuts **8** and washers **9** were used to secure the cover **2** to the base **1**. In order to avoid having a galvanic pair that would interfere with potential measurements, no metallic parts other than meshes were used (including screws, washers, and nuts).

The problem of correct measuring the potential of granulated activated carbon deserves a detailed discussion. Since the stainless steel wire mesh was used for measurement of potential as a current-carrying terminal (and, at the same time, for carbon

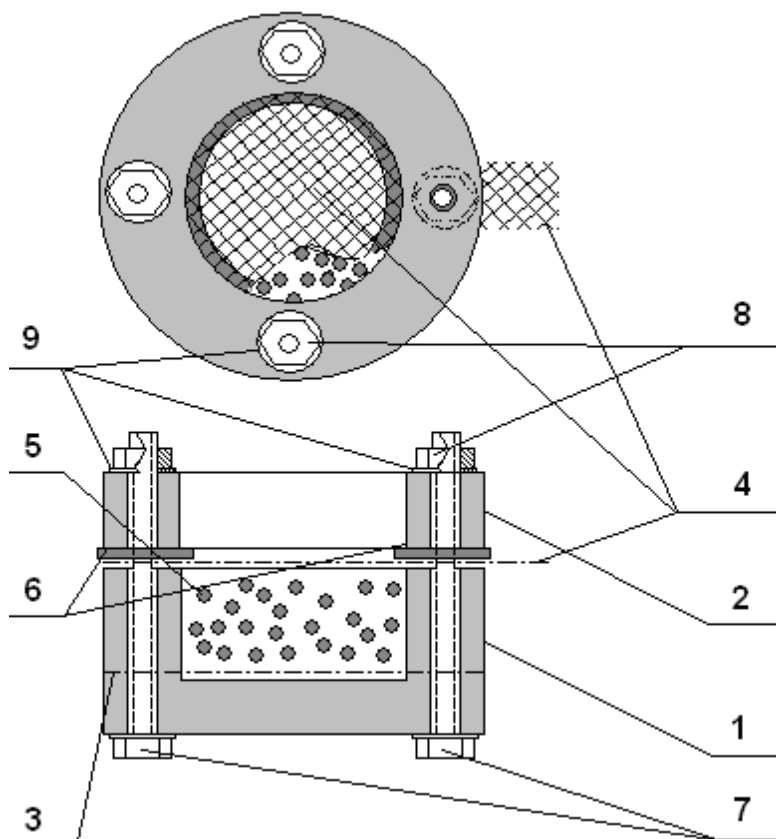

Fig. 1 Column for granulated carbon potential measurements.

compression), one must ensure that the potential measured is the potential of the activated carbon and not that of the stainless steel terminal. Indeed, in this case, only the carbon potential is measured.

While visually the two surface look comparable, the specific surface area of activated carbon is *ca.* 1000 m²/g; i.e. for a 2.0-g sample the surface area is *ca.* 2000 m², compared to not more than 10⁻³ m² (10 cm²) for the wire mesh, six orders of magnitude larger than that of the mesh. The potential-defining surface in this case is obviously the carbon surface.

The assembled device was placed into a vessel filled with 225 mL of the solution being investigated, which was continually stirred by a magnetic stirrer during the experiment. Electrical resistance and potentials of carbon samples were measured with a multimeter (M9803R - Bench Digital Multimeter, Carl's Electronics, USA) and the potentiostat IPC-Pro (NTF Volta, Russia): a silver/silver chloride reference electrode was

placed into the above vessel in near proximity of the sample, and the potential between the wire mesh terminal and the reference electrode was measured with the multimeter (corresponding to the carbon potential, as discussed above).

The total quantities of Fe^{2+} and Fe^{3+} , Cr^{6+} and Cr^{3+} were determined by flame absorption spectrometry [20] using a Buck Scientific 210-VGP Flame Atomic Absorption Spectrometer. Qualitative tests for ferrous and ferric iron complexes, as well as for chromium(III) ions and for sulfate ions in the presence of sulfite ions, were used [21].

To detect the presence of the hexacyanoferrate(II) ion, a solution of $\text{Fe}(\text{NO}_3)_3$ was used to produce a blue iron(III) hexacyanoferrate(II) precipitate:

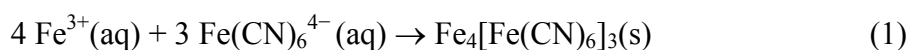

Likewise, for the hexacyanoferrate(III) ion, a solution of FeSO_4 was used to produce a blue iron(II) hexacyanoferrate(III) precipitate:

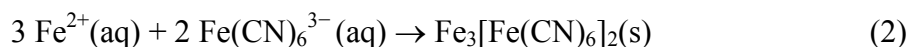

Each solution of the hexacyanoferrates was tested by adding several drops of both ferrous and ferric ion solutions.

To detect the presence of sulfates in solutions containing sulfites and the presence of sulfites in solutions containing sulfates, solutions of BaCl_2 and I_2 were used:

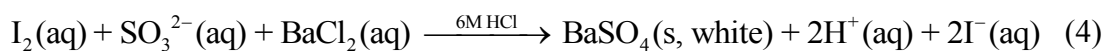

Chromium (III) ions in the presence of potassium dichromate were determined by boiling a sample of the solution being tested with 2 M KOH and a 3% solution of H_2O_2 . In the presence of Cr^{3+} , the resulting mixture yellowed.

Acetone and 2-propanol were determined by gas chromatography on a Carbowax 20M phase using the Shimadzu GC17 chromatograph. Sodium barbital (Medinal) was determined spectrophotometrically [22], using the Shimadzu UV 2401 PC spectrophotometer.

Results and Discussion

First, initial values of open circuit potential for activated carbon in aqueous solutions of inorganic substances were measured (Table 2). The initial potentials show that SKT-6A, AG-3, AR-3A are “positive,” or oxidized, carbons; AKU is a “negative,” or reduced, carbon; and VSK is an intermediate “neutral.” Time dependencies of open circuit potentials of activated carbons for the activated carbon/inorganic substance systems were measured. All dependencies were similar, and the typical curves are shown on Figure 2.

Table 2 Measured initial potentials of various activated carbon brands

| Substance | <i>E</i> (V) for Various Carbons | | | | |
|-----------------|----------------------------------|-------|-------|---------------|----------------|
| | SKT-6A | AG-3 | AR-3A | VSK | AKU |
| $K_4[Fe(CN)_6]$ | 0.242 | 0.373 | 0.088 | 0.064 | -0.036 |
| $K_3[Fe(CN)_6]$ | 0.315 | 0.374 | 0.197 | 0.040 | -0.030 |
| Na_2SO_3 | 0.280 | 0.080 | 0.270 | 0.026 | -0.042 |
| Na_2SO_4 | 0.310 | 0.455 | 0.111 | 0.075 | -0.030 |
| $NaNO_2$ | 0.270 | 0.360 | 0.100 | -0.015 | -0.032 |
| $NaNO_3$ | 0.290 | 0.360 | 0.067 | -0.016 | -0.034 |
| $ZnSO_4$ | 0.356 | 0.407 | 0.075 | 0.057 | -0.020 |
| $CuSO_4$ | 0.341 | 0.417 | 0.161 | 0.081 | 0.045 |
| $K_2Cr_2O_7$ | 0.341 | 0.360 | 0.120 | 0.035 – 0.092 | -0.060 – 0.000 |
| <i>Average</i> | 0.305 | 0.360 | 0.132 | 0.071 | -0.021 |

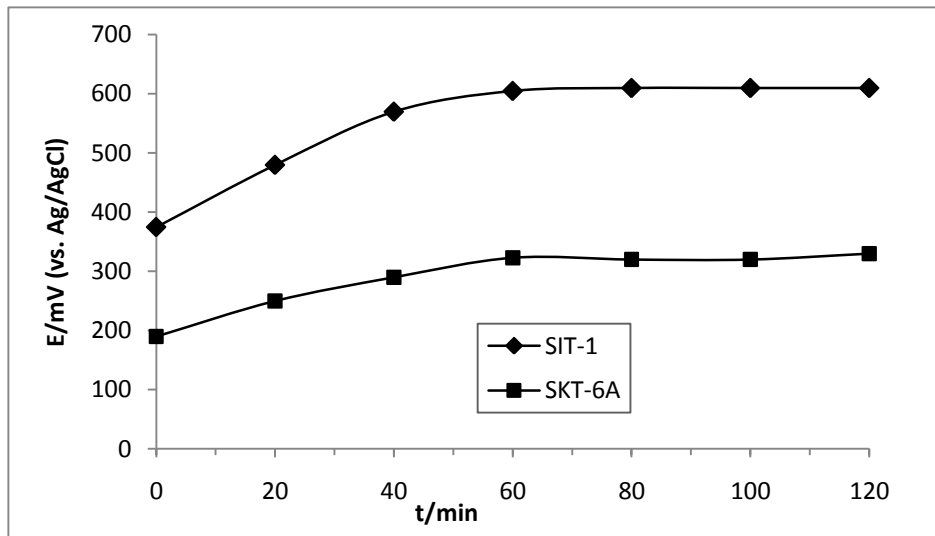

Fig. 2 Open circuit potentials of SIT-1 and SKT-6A vs. time for Medinal adsorption.

The shapes of these curves indicate that potential shifts should be measured for at least one half-hour. As seen from the data, different positive and negative potential shifts occurred. Directions and magnitudes of potential shifts obtained for the substances and

brands of carbons studied are shown in Tables 3 and 4. As seen in these tables, $K_2Cr_2O_7$, $ZnSO_4$, and $K_3[Fe(CN)_6]$ gave only positive potential shifts, whose magnitudes depended on the oxidation state of the activated carbon; the greatest positive shifts occurred with $K_2Cr_2O_7$ and $K_3[Fe(CN)_6]$ on AR-3A (269 mV and 252 mV, respectively).

Table 3 Directions of potential shifts on various carbons

| Substance | Carbon | | | | |
|-----------------|--------|------|-------|-----|-----|
| | SKT-6A | AG-3 | AR-3A | VSK | AKU |
| $K_4[Fe(CN)_6]$ | + | - | - | + | + |
| $K_3[Fe(CN)_6]$ | + | + | + | + | + |
| Na_2SO_3 | - | - | - | - | - |
| Na_2SO_4 | + | - | + | - | + |
| $NaNO_2$ | + | + | - | - | + |
| $NaNO_3$ | + | - | - | - | - |
| $ZnSO_4$ | + | + | + | + | + |
| $CuSO_4$ | + | + | + | + | + |
| $K_2Cr_2O_7$ | + | + | + | + | + |

Table 4 Values of potential shifts of investigated substances on various carbons ΔE , mV

| Substance | Carbon | | | | |
|-----------------|--------|--------|--------|--------|--------|
| | SKT-6A | AG-3 | AR-3A | VSK | AKU |
| $K_4[Fe(CN)_6]$ | 18.0 | -85.0 | -24.0 | 7.9 | 77.7 |
| $K_3[Fe(CN)_6]$ | 74.1 | 97.0 | 252.0 | 168.6 | 227.5 |
| Na_2SO_3 | -306.0 | -380.0 | -294.0 | -200.5 | -142.0 |
| Na_2SO_4 | 11.0 | -20.0 | 19.0 | -12.5 | 24.3 |
| $NaNO_2$ | 6.2 | 11.0 | -31.4 | -10.9 | 5.2 |
| $NaNO_3$ | 3.0 | -19 | -3.6 | -19 | -2.1 |
| $ZnSO_4$ | 50.0 | 22.5 | 101.0 | 30.8 | 103.0 |
| $CuSO_4$ | 86.0 | 80.0 | 180.0 | 89.0 | 96.0 |
| $K_2Cr_2O_7$ | 144.2 | 163.0 | 269.0 | 142.3 | 202.0 |

Na₂SO₃ gave only negative shifts on all carbons; the greatest negative shift of –380 mV was found on the AR-3A carbon. It should be noted that AR-3A is the most oxidized of all the activated carbons studied.

The interaction between inorganic substances K₄[Fe(CN)₆], K₃[Fe(CN)₆], and K₂Cr₂O₇ and activated carbons SKT-6A and AKU was studied in more detail. Total concentrations of iron and chromium were determined quantitatively before and after the contact of these substances with carbons; besides, the presence of Fe²⁺, Fe³⁺, Cr^{VI}, Cr³⁺, S^{IV} and S^{VI} were determined qualitatively. It was found that the total concentrations of iron and chromium were unchanged, while the ratios of [Fe²⁺]/[Fe³⁺], [Cr^{VI}]/[Cr³⁺] and [SO₃²⁻]/[SO₄²⁻] were changed in the following reactions:

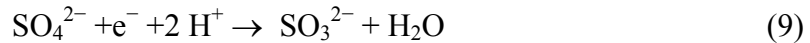
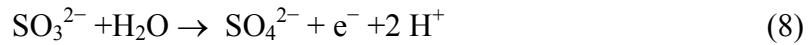

Thus, it was shown that interaction between inorganic salts and activated carbons did not lead to adsorption of either cations or anions, since the total amounts of iron, chromium, and sulfur was unchanged after the contact of the salt solutions with carbons. On the contrary, redox transformations of the salts were occurring on carbon surface. Therefore, it was supposed that open circuit potential shifts have taken place due to charge transfer between the inorganic salt, the carbon surface, and chemisorbed oxygen. Indeed, the oxidizing agent potassium dichromate was reduced and transformed into chromate, while the surface of activated carbon was oxidized; at the same time, the open circuit potential of carbon shifted in the positive direction. Moreover, the reducing agent sodium sulfite was oxidized and transformed into sulfate, while the surface of activated carbon was reduced; at the same time, the open circuit potential of carbon shifted in the negative direction.

Therefore, the cause of potential shifts when activated carbons come into contact with the above mentioned inorganic substances is quite clear—*viz.*, electron exchange occurs between the electrolyte and the surface of activated carbon, resulting in oxidation or

reduction of surface compounds. Indeed, similar conclusions were drawn in an earlier work [7].

It was a more daunting task to understand the nature of potential shifts for inorganic substances that do not possess significant redox properties. For example, copper and zinc sulfates gave only positive shifts when in contact with any of carbons studied. The largest magnitudes of shifts were obtained on AR-3A carbon (180 mV for copper and 101 mV for zinc sulfates), although shifts on other carbons were also quite considerable, *ca.* 90-100 mV, except those on AG-3 and VSK for zinc sulfate (22.5 mV and 30.8 mV, respectively). In our previous publication [7] it was shown that both cations were adsorbed on polarized carbons SKT-6A and SIT-1, and the adsorption activity depended on the nature and potential of carbon. It is probable that potential shifts may have been caused by specific adsorption of copper and zinc cations on the carbons investigated, and the difference in magnitudes could be attributed to different specific adsorption activities of copper and zinc cations on different carbons.

Potential shifts for sodium sulfate, nitrate and nitrite were the smallest in magnitude. It was supposed that potential shifts in that case may be attributed either to low specific adsorption or to ion-exchange properties, which oxidized activated carbons are known to possess [23]. Moreover, it has been shown that anodic treatment of activated carbon surface leads to an increase in ion exchange capacity without any change of surface or pore structure [24]. Finally, it is also known that potential shifts on platinum electrodes are caused by formation of adatoms of adsorbed ions [2], and specific adsorption of ions on activated carbons is also probable.

Thus, most likely, open circuit potential shifts of the inorganic substance/activated carbon systems are caused by electron transfer during the interaction of inorganic substances with surface compounds of activated carbon, particularly when redox or adsorption processes occur.

These considerations rendered relevant the investigation of open circuit potential shifts during adsorption of neutral organic molecules on activated carbons in order to avoid redox processes and adsorption of ions.

Potential shifts in the course of adsorption of organic substances were observed for all of the substances studied, with the exception of albumin. Figure 2 shows the time

Table 5 Adsorption of organic compounds on activated carbon SIT-1 (120 min).

| Adsorbate | C_i (M) | ω (nm ²) | A_m (mol/g) | A_{calc} (mol/g) | Θ (%) | ΔE (mV) |
|-----------------|----------------------|-----------------------------|----------------------|----------------------|--------------|-----------------|
| Acetone | 8.8×10^{-1} | 0.2 | 7.7×10^{-3} | 9.1×10^{-3} | 85 | 145 |
| 2-Propanol | 6.7×10^{-2} | 0.3 | 8.3×10^{-4} | 5.9×10^{-3} | 14 | 20 |
| Sodium barbital | 2.4×10^{-2} | 0.5 | 3.6×10^{-4} | 5.2×10^{-4} | 75 | 101 |
| Albumin | 5.0×10^{-6} | 50. | 3.0×10^{-8} | 3.6×10^{-5} | 10^{-2} | 0 |

C_i – initial concentration of adsorbate, ω - maximum cross-section of one molecule of adsorbate, A_m – measured values of adsorption, A_{calc} – adsorption values calculated for monolayer coverage, Θ – degree of coverage of activated carbon surface (or percentage of adsorbent surface covered by the adsorbate).

dependence of adsorption of sodium barbital on two activated carbons. Similar dependencies were obtained for all organic compounds investigated.

Table 5 shows the experimental and calculated data on adsorption on the activated carbon SIT-1.

The experimental data (measured adsorption values, A_m) were obtained by measuring the decrease in adsorbate concentration during 120 min as a result of adsorption. Measured adsorption A_m was computed according to equation 10 below:

$$A_m = \frac{\Delta M_{\text{solution}} \times V_{\text{solution}}}{m_{\text{carbon}}} \quad (10)$$

where $\Delta M_{\text{solution}}$ is the decrease in adsorbate concentration, V_{solution} is the volume of solution in contact with the activated carbon, and m_{carbon} is the dry mass of the activated carbon sample. The adsorption values calculated for monolayer coverage A_{calc} were computed according to equation 11:

$$A_{calc} = \frac{S_{\text{carbon}}}{\omega \times N_A} \quad (11)$$

where S_{carbon} is the specific surface area of sorbent (m²/g), N_A is Avogadro's number (6.022×10^{23} mol⁻¹), and ω is the maximum cross-section of one molecule of adsorbate (m²). Literature values of molecule cross-sections were used [25]. Specific surface of carbon were discussed earlier and shown in Table 1.

Again, the potential of activated carbon did not change during the adsorption of albumin, while the adsorption of other adsorbates led to shifts of initial potentials in the

positive direction. It is also noteworthy that the magnitude of these shifts depends on the degree of coverage of active carbon surface.

Based on these data, one can suggest that desorption of the adsorbates from activated carbon should lead to a reversal of potential shifts in the negative direction. Moreover, the magnitude of such shifts should correlate with the washed out amount of adsorbates desorbed.

To test the above hypothesis, an attempt was made to remove the adsorbed compounds from the surface of activated carbon; open circuit potentials of the adsorbent were measured during this process. Desorption of the adsorbates from activated carbon by washing with water was observed for all compounds except albumin, which did not show any appreciable desorption. Moreover, the degree of desorption was different for all adsorbates. It was found that desorption of adsorbates from the adsorbent led to reverse shifts of the potential in the negative direction. The magnitude of such reversals was shown to correlate with the amount of adsorbate eliminated. For example, eliminating 47% of adsorbed acetone on the surface of SIT-1 adsorbent led to a reverse potential shift of 53%; eliminating 41% of acetone off the SKT-6A adsorbent, to a reverse shift of 50%; eliminating 98% of 2-propanol off the SIT-1 adsorbent, to a reverse shift of 132%.

Thus, it was shown that the magnitude of potential shifts is directly related to the degree of coverage of activated carbon surface. It should be emphasized that the adsorption/desorption data confirmed the qualitative dependence of potential shifts of active carbon on the filling of the adsorbent surface.

The presence of open circuit potential shifts for systems without any redox transformations could be explained by the influence of adsorbed organic substances on the parameters of double electric layer (more precisely, its capacitance) because the dielectric coefficient for all of the organic compounds studied is considerably distinguishable from that of water.

Conclusions

Activated carbon open circuit potential shifts occur in systems of activated carbon/aqueous solution of inorganic or organic substances. Positive and negative potential shifts of varying magnitudes were observed. Activated carbon open circuit potential shifts in aqueous solutions can be caused by reduction/oxidation, as well as by

adsorption activity of inorganic or organic substances towards activated carbon. Magnitudes of activated carbon open circuit potential shifts depended on the degree of coverage of the activated carbon surface by the adsorbate. The phenomenon of activated carbon open circuit potential shifts could be used to ascertain whether a given organic or inorganic substance interacts with the surface of activated carbon and to elucidate the mechanisms of such interactions.

References

1. Frumkin AN (1982) Potentsialy Nulevogo Zaryada. Nauka, Moscow (in Russian)
2. Podlovchenko BI, Kolyadko TA (2001) *J Electroanal Chem* 506:11
3. Podlovchenko BI, Gladysheva TD (2001) *Russian J Electrochem* 37:771
4. Podlovchenko BI, Gladysheva TD, Kolyadko EA (2003) *J Electroanal Chem* 552: 85
5. Tokarev AV, Vidovich GL, Kultin DYU, Lebedeva OK (2003) *Vestnik Mosk Universiteta Ser Khim* 44:192 (in Russian)
6. Takabayashi S, Kato N, Nakato Y (2006) *J Electrochem Soc* 153:E38
7. Goldin MM, Volkov AG, Namyshkin DN (2005) *J Electrochem Soc* 152:E167.
8. Frumkin AN, Petrii OA, Damaskin BB (1980) in: Yeager E, Bockris JO'M, Conway B, Sarangapany S (eds) *Comprehensive Treatise of Electrochemistry*, Vol. 1, pp. 221-285, Plenum Press, New York
9. Bockris JO'M, Davanathan MA, Muller VK(1963) *Proc Royal Soc London* A274:55
10. Bockris JO'M, Gileadi E, Muller K (1967) *Electrochim Acta* 12:1301
11. Goldin MM, Volkov AG, Namyshkin DN, Filatova EA, Revina AA (2005) *J Electrochem Soc* 152:E172
12. Rivera-Utrilla J, Bautista-Toledo I, Ferro-García MA, Moreno-Castilla C (2001) *J Chem Technology Biotechnology* 76:1209
13. Fischer VM (2001) In situ electrochemical regeneration of activated carbon. Dissertation, University of Groningen
14. Lee GJ, Pyun SI, Kim CH (2004) *J Solid State Electrochem* 8:110
15. Schilow N, Schatunowskaya N, Tschmutow K (1930) *Z Phys Chem A* 149:211

16. Steenberg B (1944) Adsorption and Exchange of Ions on Activated Charcoal, Almquistandwiksells, Uppsala
17. Garten VA, Weis DE (1957) Austral J Chem 10:309
18. Tarasevich MR (1984) Elektrokhimiya Uglerodnykh Materialov. Nauka, Moscow (in Russian)
19. Marsh H, Reinoso FR (2006) Activated Carbon, Elsevier, Amsterdam
20. Holler DA, Nieman FJ, Skoog TA (1998) Principles of Instrumental Analysis, 5th ed., Saunders College Publishing, Chicago
21. Kreshkov AP (1970) Fundamentals of Analytical Chemistry, 3rd edn. Vol. 1, Khimiya, Moscow
22. Luzhnikov EA, Goldin MM, Morozov VS (1982) In: Menshikov VV (ed) Rukovodstvo po Klinicheskoi Laboratornoi Diagnostike, pp. 546–560, Meditsina, Moscow, (in Russian)
23. Tarkovskaya IA (1981) Oxidized Carbon, Naukova Dumka, Kiev (in Russian)
24. Park SJ, Kim KD (1999) J Colloid Interface Sci 218:331
25. Bogdanova VA, Tarasevich MR, Goldin MM (1990) In: Itogi Nauki i Tekhniki, series “Elektrokhimiya,” Vol. 31, pp. 151-166. Nauka, Moscow (in Russian)